

SECTION A-A

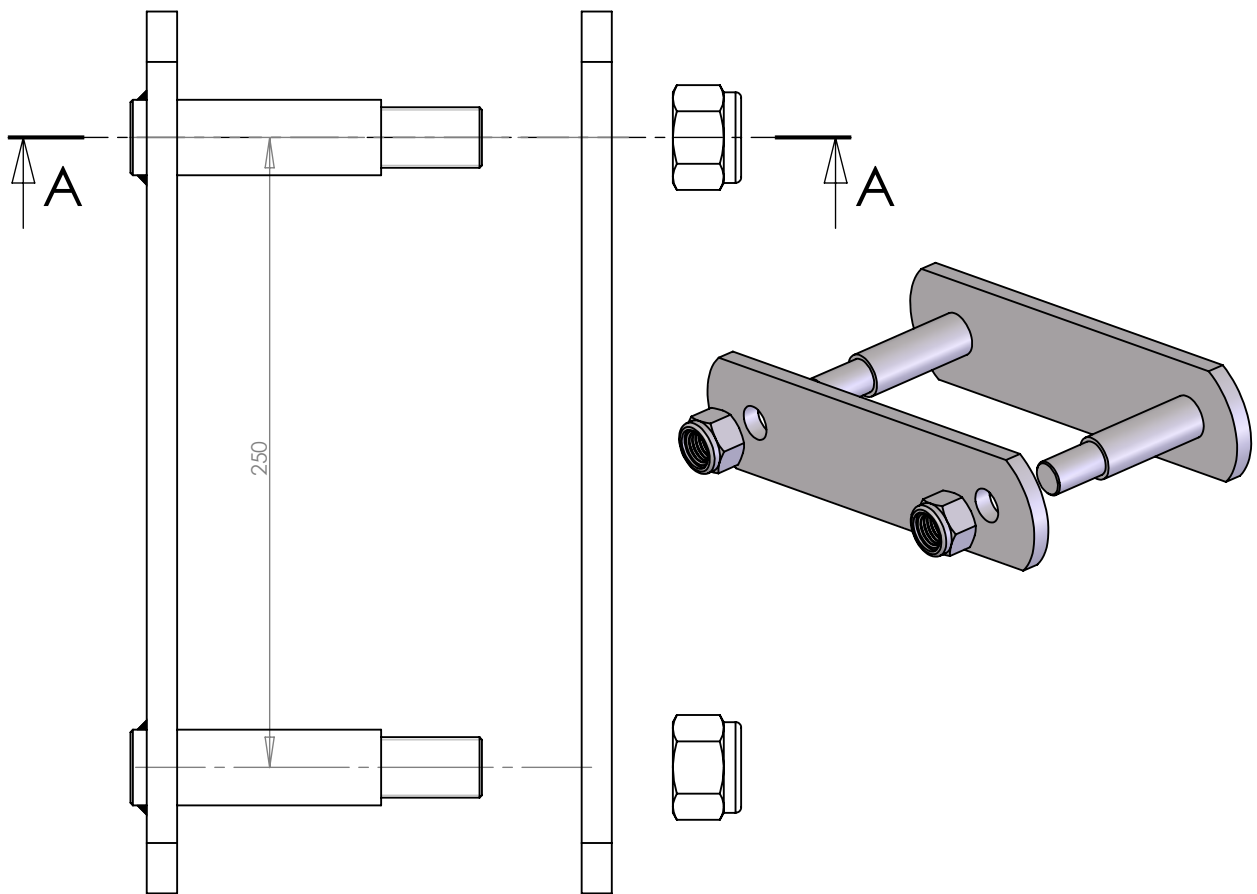

Scanchain
 Holmensvej 36A
 DK-3600 Frederikssund
 T: +45 702 796 00
 M: +45 402 402 13
 www.scanchain.dk

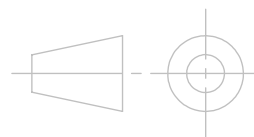

PROCESS DRW:

UNLESS OTHERWISE SPECIFIED:
 DIMENSIONS ARE IN MILLIMETERS

TOLERANCES: 0,2mm
 LINEAR:
 ANGULAR:

Debur and break sharp edges.

MATERIAL:

WEIGHT:

PROPRIETARY AND CONFIDENTIAL

THE INFORMATION CONTAINED IN THIS DRAWING IS THE SOLE PROPERTY OF SCANCHAIN. ANY REPRODUCTION IN PART OR AS A WHOLE WITHOUT THE WRITTEN PERMISSION OF SCANCHAIN IS PROHIBITED.

SCALE		REVISION:	
NAME	DATE		
DRAWN			
REV.			

TITLE:

M450-A-250 WP CL M24

DRAWING NO.

A

DO NOT SCALE DRAWING

SHEET 1 OF 1