

SECTION A-A

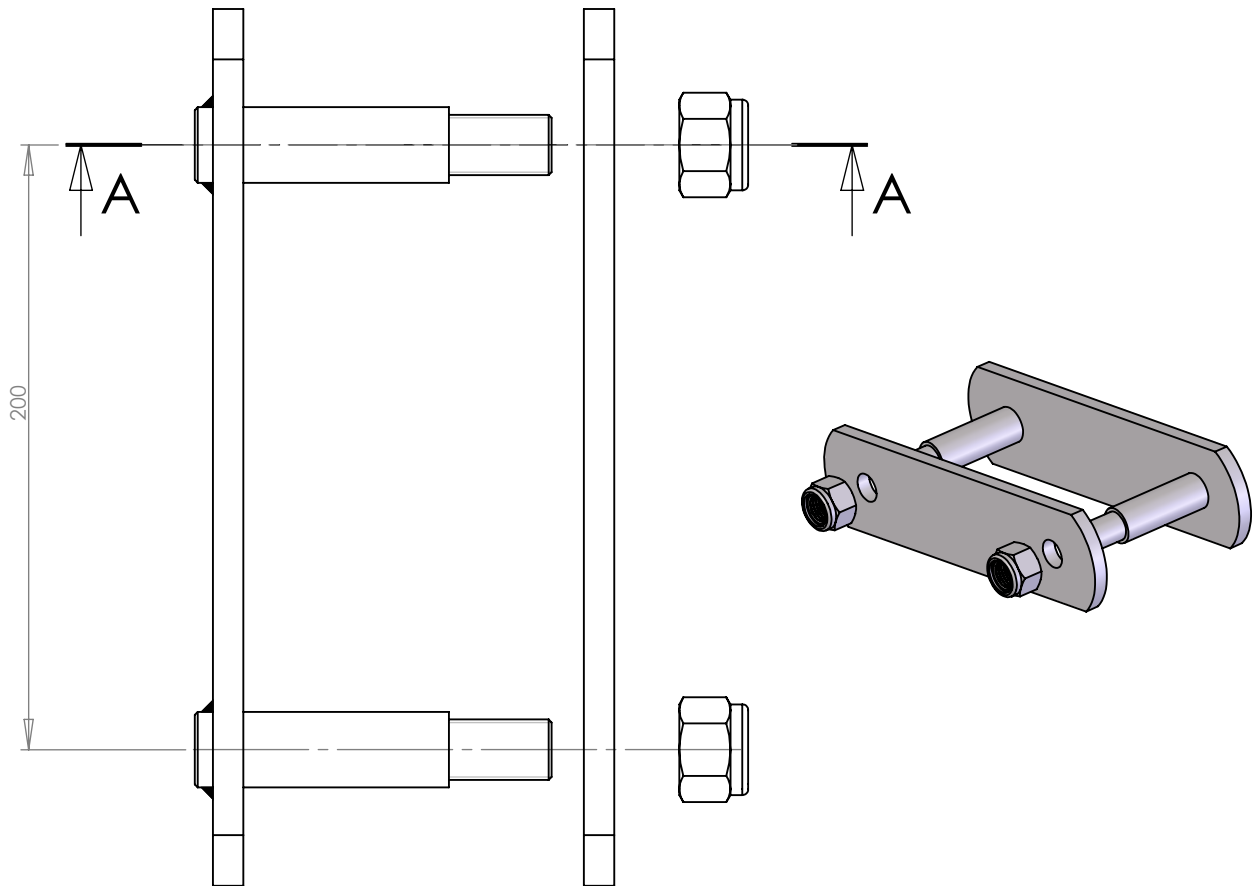

Scanchain  
 Holmensvej 36A  
 DK-3600 Frederikssund  
 T: +45 702 796 00  
 M: +45 402 402 13  
 www.scanchain.dk

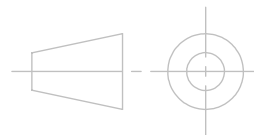

PROCESS DRW:

UNLESS OTHERWISE SPECIFIED:  
 DIMENSIONS ARE IN MILLIMETERS

TOLERANCES: 0,2mm  
 LINEAR:  
 ANGULAR:

Debur and break sharp edges.

MATERIAL:

WEIGHT:

PROPRIETARY AND CONFIDENTIAL

THE INFORMATION CONTAINED IN THIS DRAWING IS THE SOLE PROPERTY OF SCANCHAIN. ANY REPRODUCTION IN PART OR AS A WHOLE WITHOUT THE WRITTEN PERMISSION OF SCANCHAIN IS PROHIBITED.

SCALE	REVISION:	
	NAME	DATE
DRAWN		
REV.		

TITLE:

M315-A-200WP CL M20

DRAWING NO.

A

DO NOT SCALE DRAWING

SHEET 1 OF 1